

Varenummer: 204801V10300ALLS

Beskrivelse: E+G Firkantrør med scala - GN 480.1-V10-300-AL-LS

Mål

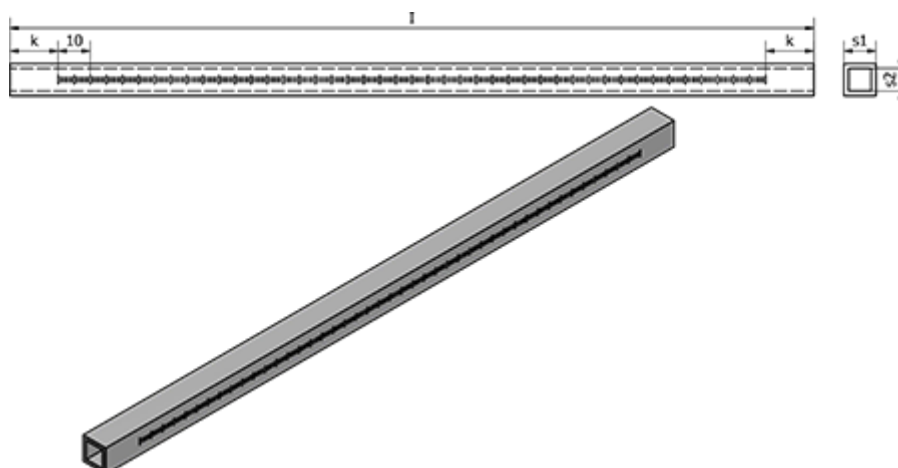

l	= 300
k	= 15
s1	= V10
s2	= 7
Vægt (g)	= 38